



Case Steiger (Tier 4)

Joystick Installation Instructions

For Models:

Case Steiger Wheeled - 350, 370, 400, 420, 450, 470, 500, 540, 550, 580, 600, 620

Case Steiger Quad - 450, 470, 500, 540, 550, 580, 600, 620

Purchase Date
Serial Number
Model Number
Tractor Model
Dealer

Index

Description	Page
Bolt Torque Specifications	2
Inventory	3
Bracket and Joystick Installation	4-5
Valve Bracket Installation	5
Plumbing	6-8
Cable Installation	8-9
Valve Cover Installation	10
Joystick Operation	10
Joystick and Hydraulic Schematic	11,12,13
Notes	14,15
Warranty	16

Bolt Torque Specifications

Bolt Dia. (inch)	Thread per inch	Grade 5	Grade 8
		Torque (ft·lbs.)	Torque (ft·lbs.)
1/4	20	8	12
1/4	28	10	14
5/16	18	17	25
5/16	24	19	29
3/8	16	30	45
3/8	24	35	50
7/16	14	50	70
7/16	20	55	80
1/2	13	75	110
1/2	20	90	120
9/16	12	110	150
9/16	18	120	170
5/8	11	150	220
5/8	18	180	240
3/4	10	260	380
3/4	16	300	420
7/8	9	430	600
7/8	14	470	660
1	8	640	900
1	12	710	990

Bolt Dia. (mm)	Pitch	Grade 8.8	Grade 10.9
		Torque (ft·lbs.)	Torque (ft·lbs.)
4	0.70	2	
5	0.80	4	
5	1.00	7	11
7	1.00	12	
8	1.25	17	26
8	1.00	18	
10	1.50	35	51
10	1.20	37	
10	1.00	39	
12	1.75	59	88
12	1.50	62	
12	1.25	65	
14	2.00	94	139
14	1.50	101	
16	2.00	146	210
18	2.50	210	
20	2.50	292	
22	2.50	398	
44	3.00	503	

Inventory

QTY.	PN	Description
4	16-11436	10-24 x 1" Socket Head Cap Screw
1	16-20006	1/4" x 1-1/2" Hex Bolt Gr 5 NC
4	16-20034	5/16" x 1" Hex Bolt Gr 5 NC
3	16-20068	3/8" x 2" Hex Bolt Gr 8 NC
4	16-21064	3/8" x 1" Carriage Bolt Gr 5 NC
3	16-35c616	3/8" x 1" Flanged Bolt
1	18-11426	Mount, Rear Valve
1	18-16705	Steiger Tier 4 Joystick Mount
1	31-12331-6-6	-6 Male JIC to -6 ORFS Swivel (FS-7504-6-6)
2	31-15KB1212	Straight JIC x O-Ring (6400-12-12)
1	31-34033	Straight JIC x O-Ring (6400-6-5)
4	31-34041	Straight JIC x O-Ring (6400-8-10)
1	31-34099	Swivel Nut Elbow 90° JIC (6500-6-6)
1	31-34158	Male Connector -6 JIC x -4 Pipe (2404-6-4)
1	31-34169	Male Elbow 90° JIC x Pipe (2501-6-4)
2	31-34259	Straight Thread Elbow 90° JIC x Metric (-12-27)
2	31-6400-12-10	Straight JIC x O-Ring (6400-12-10)
1	31-FS-2404-06-04	OFS Male Pipe Connector
1	35-7105975	15" 6FJX 6FJX - 90
2	35-11684-0690	-12FJIC x -12 FJIC - 69"
1	35-11694-0700	-6 FJIC x -6 FJIC - 70"
1	44-11424	Valve Mount Cover- STX / Danfoss
1	44-11435	Plate, Retaining Ring / SureGrip
1	44-16712	Steiger Tier 4 Joystick Middle Bolting Plate
1	44-16713	Steiger Tier 4 Joystick Armrest Bolting Plate
1	56-11653	3 Spool Valve/Joystick
1	56-11658	Shuttle Valve - JD and STX
1	56-12424	Joystick Wire Harness
1	56-12426	Joystick
1	57-20740	1/4" Flat Washer
3	57-20742	3/8" Flat Washer
4	57-20741	5/16" Flat Washer
10	59-34951	Zip / Cable Tie 50# 15.5"
1	69-11663	Joystick Extension Cord 30'
1	70-20580	1/4" Hex Nut Gr 5 NC
3	70-20612	3/8" Nyloc Nut NC
4	70-20622	3/8" Flange Hex Nut Gr 5 NC

Bracket & Joystick Installation

NOTE: Your machine may vary slightly from the machine in this manual, but the same installation procedure will be compatible.

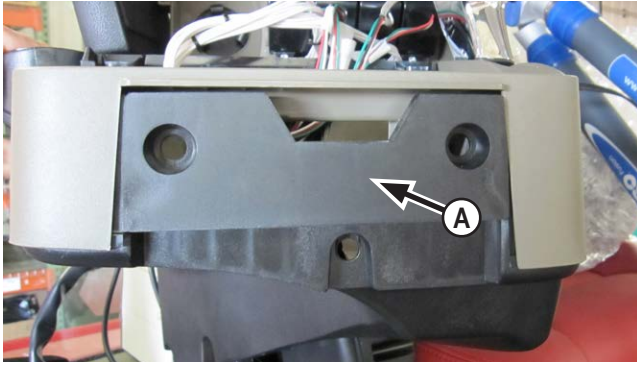

1. Remove the cover or the monitor mount from the front of the armrest (A).

NOTE: The following pictures show the joystick assembly already in place. The joystick will be installed in a later step.

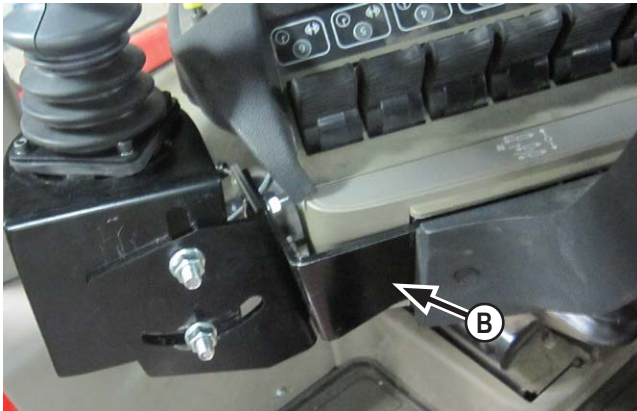

2. Attach the bolting plate (PN: 18-16713) along with the cover or monitor mount to the front of the armrest with the original hardware from step #1. Put the bracket between the armrest and the cover or monitor mount (B).

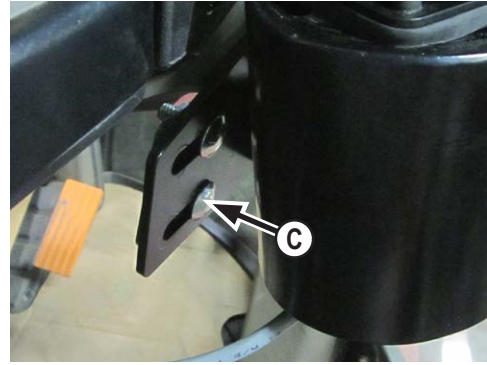

3. Attach the small middle bolting plate (PN: 44-16712) to the bracket from Step #2 with 2 - 3/8" x 1" carriage bolts and 2 - 3/8" flange nuts (C).

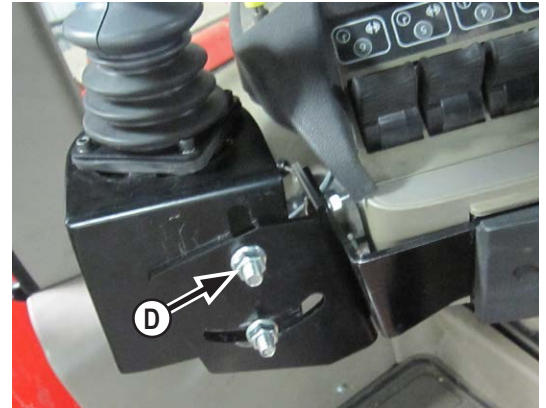

4. Attach the joystick mount (PN: 18-16705) to the bracket from Step #3 with 2 - 3/8" x 1" carriage bolts and 2 - 3/8" flange nuts (D).

Joystick Installation



5. Hold the mounting ring (PN: 44-11435) inside the side mount, and attach the joystick to the top of the side mount and the mounting ring with 4 - 1" socket head cap screws (**E**).

6. Adjust the joystick and mounts to position the joystick to the operator's preference. Once the joystick is in the correct position, tighten all of the fasteners.

Valve Bracket Installation



7. Attach the control valve to the valve mount with 4 - 5/16" x 1" bolts and 4 - 5/16" flat washers.

8. Attach the rear valve mount (PN: 18-11426) to the rear of the tractor. Use 3 - 3/8" x 2" bolts, 3 - 3/8" flat washers, 3 spacers, and 3 - 3/8" nuts to attach the mount to the side of the tractor frame (**F**).

NOTE: Cables are shown in photo. The cables will be installed in a later step.

Plumbing



NOTE: Valve shown from the bottom.

9. Attach the 69" hoses to the two fittings on the control valve that are closest to the rear of the tractor (**G**).

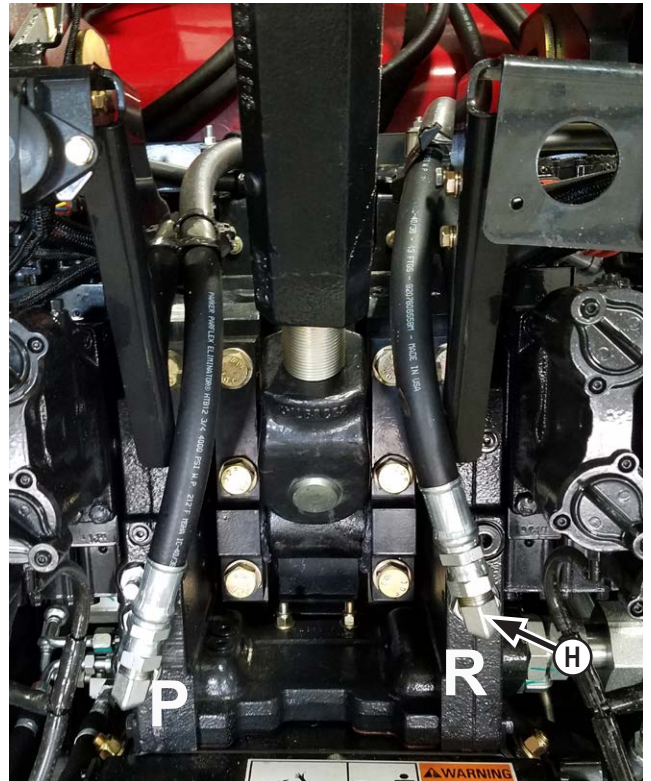

NOTE: Oil will flow. Be ready with an oil pan.

10. Remove the plug or quick connect from the **P** and **R** ports at the rear of the tractor and replace each with a 90° fitting (PN: 31-34259) (**H**).

11. Attach the 69" hose from the **bottom** fitting on the control valve to the 90° fitting at the **P** port.

12. Attach the 69" hose from the **top** fitting on the control valve to the 90° fitting at the **R** port.

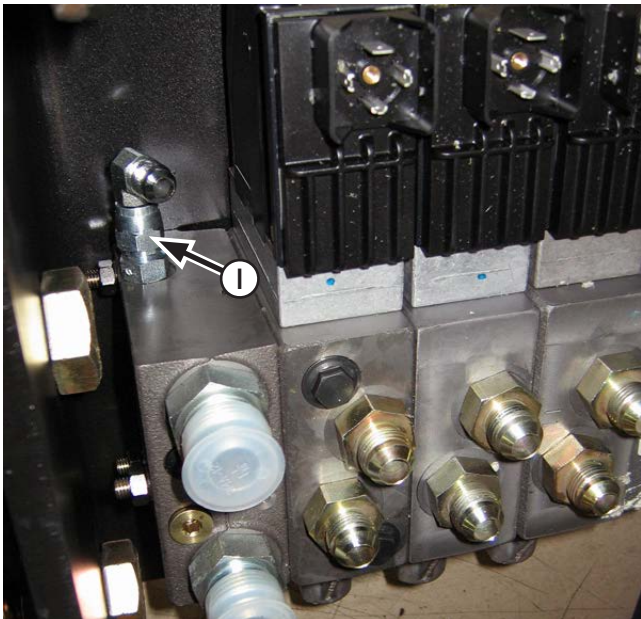

13. If fittings are not installed in the LS port on the control valve, install a straight -6-5 fitting (PN: 31-34033) and a 90° -6-6 fitting (PN: 31-34099) in the LS port (**I**).

14. Attach a 70" hose (PN: 35-11694-0470) to the 90° fitting in the LS port.

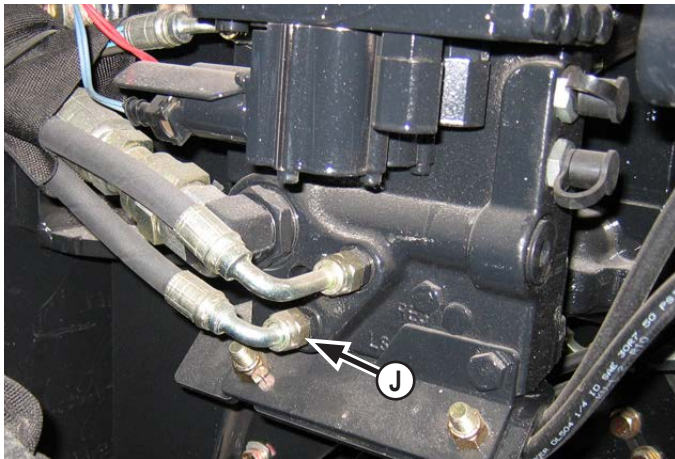

15. On the left side of the manifold valve, disconnect the bottom hydraulic line (**J**).

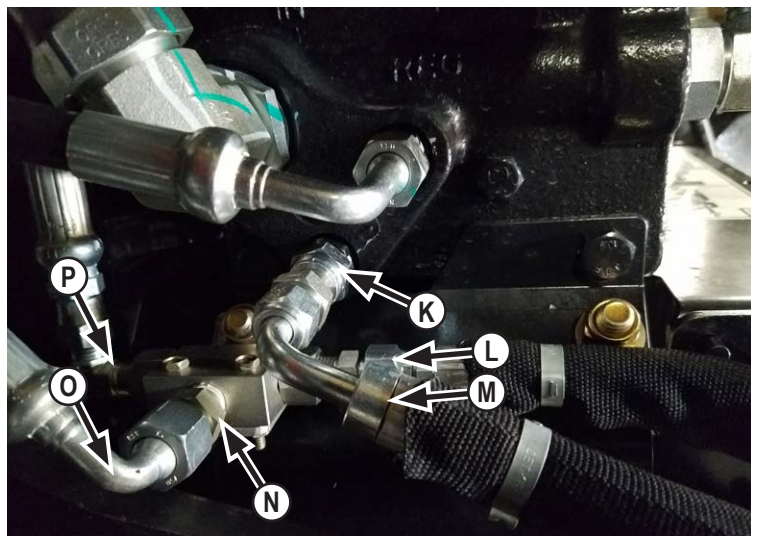

16. Install a JIC x Face Seal Swivel (PN: 31-12331-6-6) to the fitting that the hydraulic line was removed from (**K**).

17. Install a male pipe x male JIC straight fitting (PN: 31-34158) (**L**) in the side port on the shuttle valve.

18. Connect a hose from the fitting on the tractor to the fitting previously installed (**M**).

19. Install a male pipe connector fitting (PN: 31-FS-2404-06-04) (**N**) in the top port on the shuttle valve.

20. Attach the previously disconnected hydraulic line from Step #15 to the male fitting on the shuttle valve (**O**).

21. Install a male pipe x male JIC 90° fitting (PN: 31-34169) (**P**) in the side port on the shuttle valve.

22. Attach the 70" hose from Step #14 to the male elbow fitting on the shuttle valve from Step #21 (**P**).



NOTE: Valve shown from the bottom.

- 23.** Guide the dozer **lift** hoses to the rear of the tractor. Wrap a hose protector around the hoses. If necessary, use zip ties to keep the hose protector in place.
- 24.** Attach the dozer **Lift** hoses to the corresponding fittings on the control valve (**Q**). The hose with 2 orange spiral rings goes to the top fitting on the control valve. The hose with 1 orange spiral ring goes to the **bottom** fitting on the control valve.
- 25.** Guide the dozer **Angle** and **Tilt** hoses to the rear of the tractor. Attach the dozer **Angle** and **Tilt** hoses to the corresponding fittings on the control valve.
- 26.** Use zip-ties to hold the hoses into place.

Cable Installation

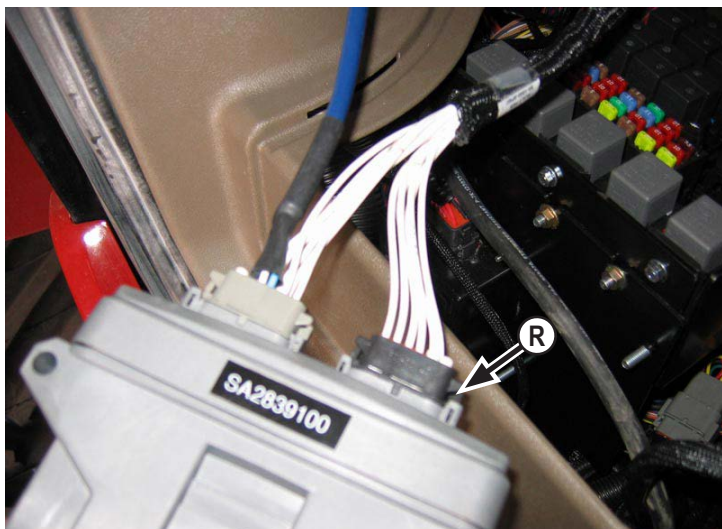

- 27.** Set control box in fuse compartment (**R**).

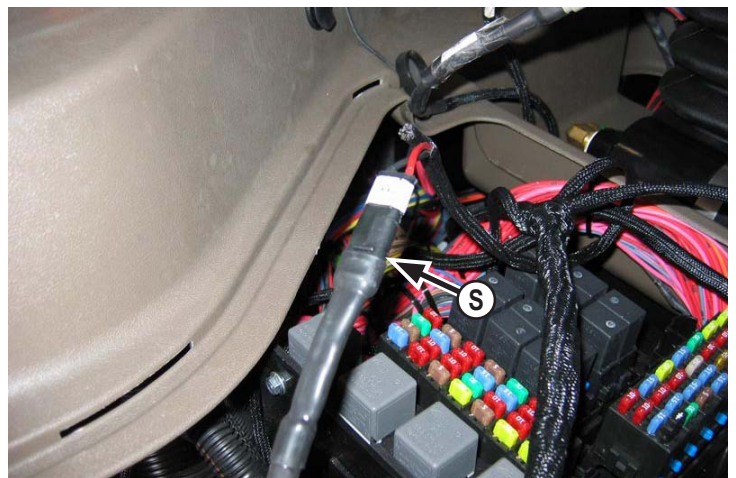

- 28.** Connect the dozer angle extension cord (PN: 69-11663) to the wire harness (**S**). Run the cord through the hole in the floor of the fuse compartment.
- 29.** Guide the extension cord from the wire harness to the front of the tractor. Run the wire along the hoses on the left side of the lift system.
- 30.** Connect to the blade side angle wire harness at the top arm.

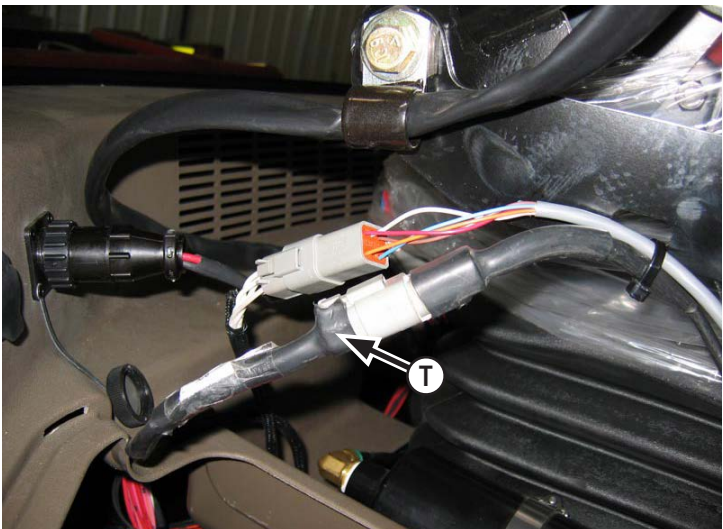

31. Connect the cable from the joystick to the wire harness (T).

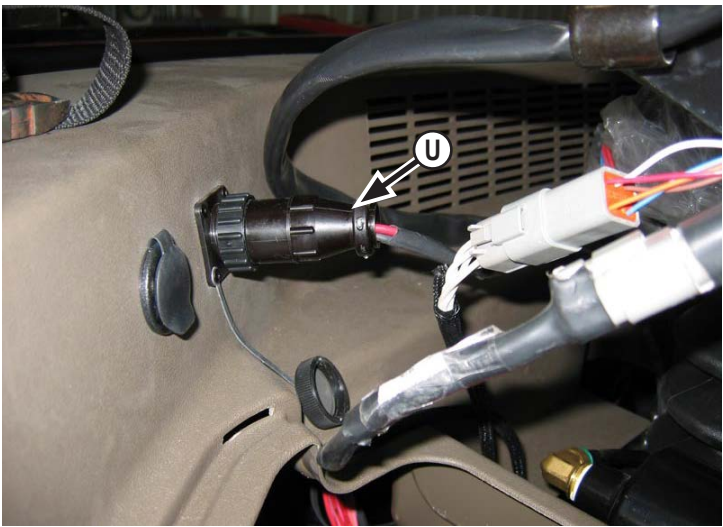

32. Plug the power cord from the wire harness into the port located behind and to the right of the operator's seat in the tractor cab (U).



33. Guide the 3 cables and Dins from the wire harness out to the rear of the tractor.

NOTE: When routing the wire harness follow other hoses and wires through the pivot area of the tractor. Route the wire harness so that it will not be repeatedly bent in any area or rubbing on any sharp edges when the tractor is in use.

34. Put the supplied rubber seal on each Din connector.

35. Connect the **Lift**, **Tilt**, and **Angle** Dins to the corresponding connections on the back of the control valve.

36. Use screws to fasten the Dins to the control valve (V).

NOTE: The electric dozer functions can be overridden by attaching the supplied handles to the control valve and operating them.

37. Use zip-ties to hold cables in place.

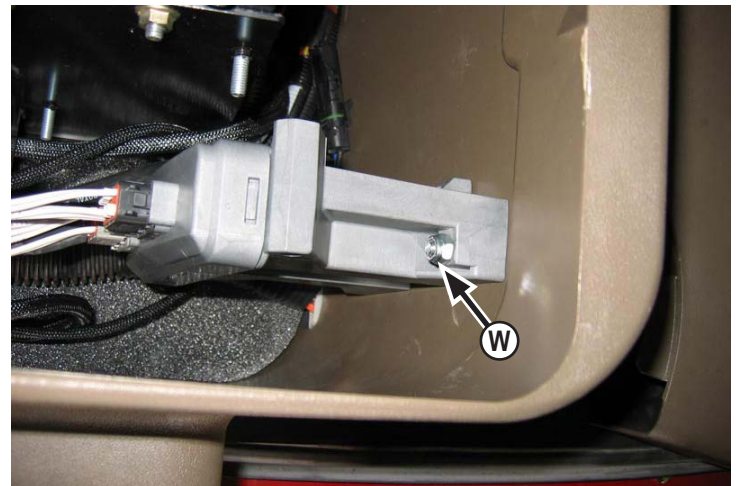

38. Drill a hole for a 1/4" bolt in the fuse compartment. Attach the wire harness to the compartment with a 1/4" bolt, 1/4" washer, and a 1/4" nut (W).

Valve Cover Installation



- 39.** Place the valve cover over the valve and hoses as shown in the picture. Verify that the hoses are not being pinched.
- 40.** Attach the valve cover to the valve bracket with 3 - 3/8" x 1" bolts (**X**).

Joystick Operation

- 41.** To **raise** the blade **up**, **pull back** on joystick.
- 42.** To **lower** the blade **down**, **push forward** on joystick.
- 43.** To **tilt** the blade **left**, tilt the joystick to the **left**.
- 44.** To **tilt** the blade **right**, tilt the joystick to the **right**.
- 45.** To extend and retract the **right** side of the blade, operate the rocker button on the top of the joystick.
- 46.** To extend and retract the **left** side of the blade, hold down the trigger switch on the joystick handle and operate the rocker button on the top of the joystick.
- 47.** To operate the float function, push the bottom switch on the left side on the top of the joystick.
- 48.** To cancel the float function, actuate the joystick.
- NOTE:** If directions are not correct, go to Step #24 and #25 on Page 8 and verify that the hoses are installed correctly.

Joystick Schematic

THE INFORMATION CONTAINED IN THIS DRAWING IS THE SOLE PROPERTY OF GROUSER PRODUCTS INC. ANY REPRODUCTION IN PART OR WHOLE WITHOUT THE WRITTEN PERMISSION OF GROUSER PRODUCTS INC IS PROHIBITED.

CONNECTOR C6B, CONNECTS TO HARNESS CONNECTOR C6A

JOYSTICK "X" AND "Y" AXIS AND
5VDC PWR AND GND

FROM JOYSTICK

<	1	-	RED (5 VDC PWR)
<	2	-	BLACK (5 VDC GND)
<	3	-	WHITE ("X" AXIS)
<	4	-	BLUE ("Y" AXIS)

JOYSTICK AUXILIARY FUNCTIONS
12 VDC

FROM JOYSTICK

<	5	-	ORANGE (TRIGGER)
<	6	-	BLUE (TOP LEFT PB - ANGLE INC)
<	7	-	BROWN (BOTTOM RIGHT - FLOAT)
<	8	-	WHITE (BOTTOM LEFT - ANGLE DEC)
<	9	-	RED (12 VDC PWR)
<	10	-	NOT USED
<	11	-	NOT USED
<	12	-	NOT USED



GROUSER PRODUCTS INC.
755 2nd Ave NW
West Fargo, ND 58078
WWW.GROUSER.COM
Phone 701.282.7710
Fax 701.282.8131

TITLE: SA-2839-SCH-JOYSTICK2

Date: 6/14/2007 DWG. NO.:

Joystick Schematic

THE INFORMATION CONTAINED IN THIS DRAWING IS THE SOLE PROPERTY OF GROUSER PRODUCTS INC. ANY REPRODUCTION IN PART OR WHOLE WITHOUT THE WRITTEN PERMISSION OF GROUSER PRODUCTS INC. IS PROHIBITED.

SUNSOURCE STD PORT DESCRIPTIONS

○	PWR
●	SHIELD
△	SENSOR PWR
▲	SENSOR GND
○	CAN+
○	CAN-
○	CAN D
○	CAN1 +
○	CAN1 -
○	CAN1 1

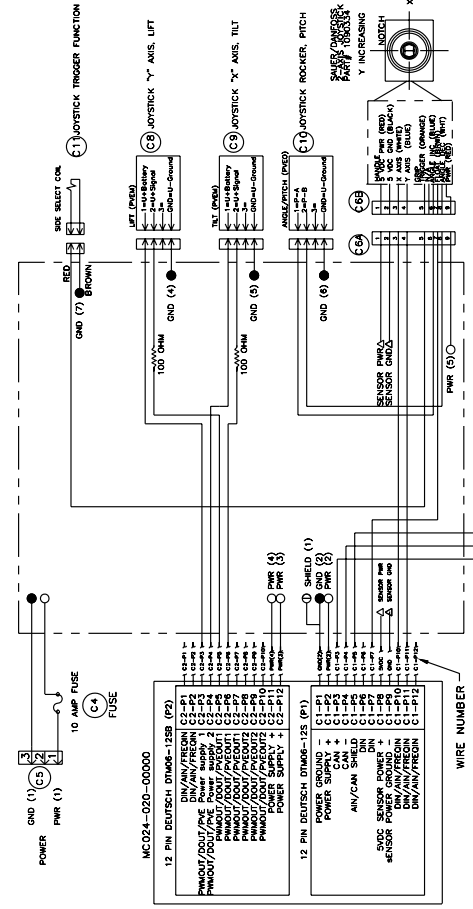

USE ZIP TIE STYLE TAG TO LABEL AS SHOWN WITH WHITE WITH BLACK TEXT WITH PANDUIT #PLT1M-M100 CABLE TIES (3) PLACES

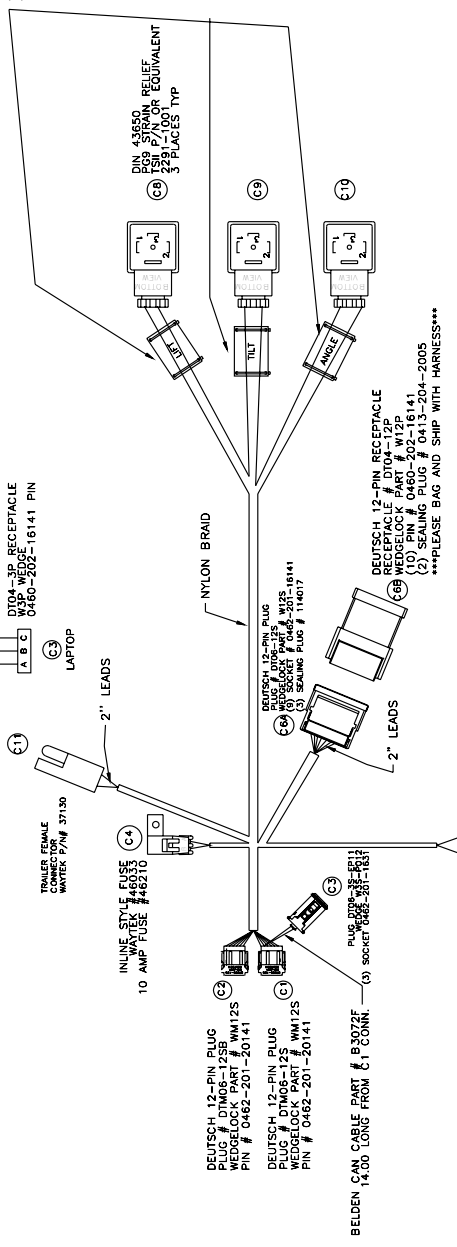

NOTE: UNLESS OTHERWISE SPECIFIED ALL DIMENSIONS ARE IN INCHES WIRE TO BE 18AWG GXL WHITE WITH BLACK TEXT - "VIDEOJET #2" OR "DOMING" EQUIVALENT. "C" NUMBER TO BE ON ALL CONNECTORS USING POLY STICKER REFERENCE "BUILT PER SA-1000-SPEC" ON HARNESS LABEL.



GROUSER PRODUCTS INC.
 755 2nd Ave NW
 West Fargo, ND 58078
 WWW.GROUSER.COM
 Phone 701.282.7710
 Fax 701.282.8131

TITLE: SA-2839-MA2
 Date: 6/14/2007 DWG. NO.:

Hydraulic Schematic

THE INFORMATION CONTAINED IN THIS DRAWING IS THE SOLE PROPERTY OF GROUSER PRODUCTS INC. ANY REPRODUCTION IN PART OR WHOLE WITHOUT THE WRITTEN PERMISSION OF GROUSER PRODUCTS INC IS PROHIBITED.

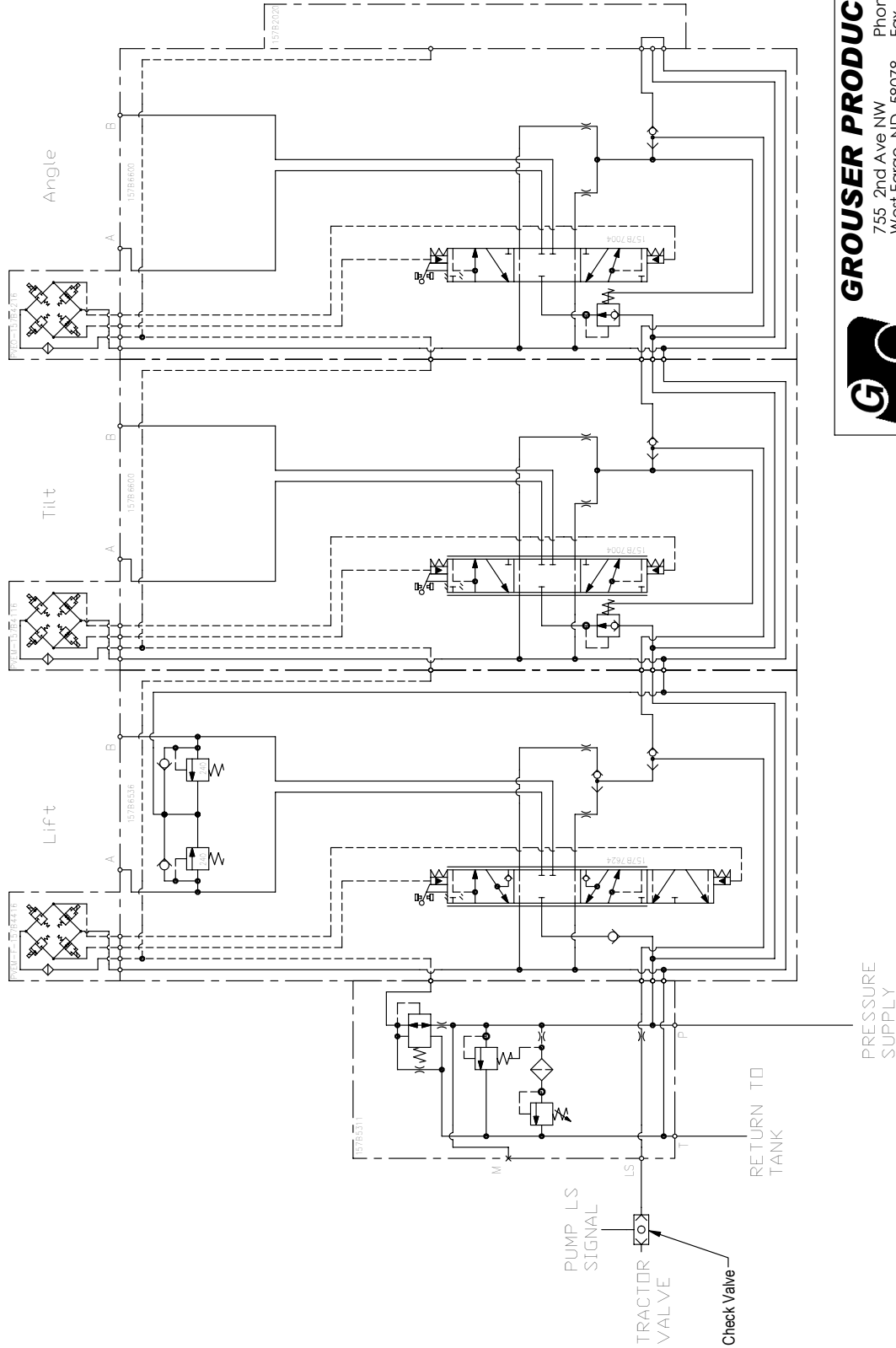

GROUSER PRODUCTS INC.
 755, 2nd Ave NW
 West Fargo, ND, 58078
 WWW.GROUSER.COM
 Phone 701.282.7710
 Fax 701.282.8131

TITLE: Valve Hydraulic Schematic

Date: 5-1-2007

DWG. NO.: STX

Notes

Notes

Improvements

Grouser Products Inc. is continually striving to improve its products. We reserve the right to change prices, specification, or equipment at any time without notice. We also reserve the right to make improvements or changes when it becomes practical and possible to do so without incurring any obligation to make changes or additions to the equipment sold previously.

Warranty

Grouser Products warrants to the original purchaser of each item that the product be free from defects in material and workmanship under normal use and service for a period of **two (2) years for Agriculture Series Blades and one (1) year for Heavy Duty Series from date of original retail delivery.**

The obligation of the consumer under this warranty:

1. To read the operators manual and to operate, lubricate, maintain and store equipment in accordance with the instructions listed in the operators manual.
2. To inspect equipment and if any part needs repair or replacement when continued use would cause damage or wear to other parts or safety.
3. All equipment or parts claimed to be defective in material or workmanship must be made available for inspection at the place of business of a dealer authorized to handle the equipment covered by this warranty, or, upon request by Grouser Products, shipped to the Grouser Products factory in West Fargo, North Dakota.

The obligation of the dealer under this warranty:

1. Complete warranty registration form and submit within 30 days of sale.
2. Contact Grouser Products for authorization prior to performing any warranty repairs or part replacement.
3. Complete warranty request form and submit with photos and supporting documentation.

The obligation of Grouser Products under this warranty:

1. Repair or replace, any equipment or parts, in the judgment of Grouser Products to be defective in material or workmanship.
2. Grouser Products will cover the cost of parts and ground shipping at dealer invoice only.
3. Grouser Products shall have no obligation to bear the cost of labor or transportation in connection with replacement or repair of any such defective parts.

This warranty does not cover:

1. Depreciation or damage caused by normal wear, accident, improper assembly, improper adjustments.
2. Improper maintenance including lack of proper lubrication, or improper use. Including loose bolts, nuts, or fitting due to over tightening or vibration after 20 hours of operation.
3. Repairs or alterations without authorization from a Grouser Products representative.
4. Grouser Products shall have no liability if the equipment has been altered or reworked without the written authorization of Grouser Products.

Grouser Products' parts, which are furnished under this warranty and properly installed, shall be warranted to the same extent as the original parts under this warranty if, and only if, such parts are found to be defective within the original warranty period covering the original equipment.

NO EMPLOYEE OR REPRESENTATIVE OF GROUSER PRODUCTS IS AUTHORIZED TO CHANGE THE WARRANTY IN ANY WAY OR GRANT ANY OTHER WARRANTY.

Contact Us

As always, if you have any questions about your system or other products made by Grouser, feel free to contact us.



755 2nd Ave NW - West Fargo, ND 58078
+1 701-282-7710 | info@grouser.com
www.grouser.com